

PartsList D28129 SMALLANGLEGRINDER 1

| Item | PartNumber | Qty | PartDescription | GeneralDescription | OtherInfo | RepairInst | Markets |
|------|------------|-----|----------------------|--------------------|-----------|------------|---------|
| 101 | 000000-00 | 1 | NOLONGERAVAILABLE | No | QS | | |
| 102 | 605527-00 | 1 | FIELD No | QS | | | |
| 103 | 945614-00 | 1 | SWITCH | No | | | |
| 104 | 939539-01 | 2 | BRUSHCUTOFF | 220-240V | No | | |
| 105 | 562226-43 | 1 | CABLESA | No | QS | | |
| 106 | 622613-02 | 1 | OUTERFLANGE | M14 | No | | |
| 107 | 391969-00 | 1 | INNERFLANGE | No | | | |
| 110 | 397661-01 | 1 | GUARDSA 115mm-Type27 | No | | | |
| 111 | 631609-02 | 1 | SCREWM5X0.8X16 | No | | | |
| 112 | 330045-46 | 4 | SCREW Yes | | | | |
| 114 | 604488-11 | 1 | SPINDLE&GEARSA | M14/36T | | No | |
| 116 | N542553 | 1 | CORDPROTECTOR | | | No | |
| 116 | N542553 | 1 | CORDPROTECTOR | | | No | |
| 118 | 562097-01 | 4 | SCREW Yes | | | | |
| 119 | 000000-00 | 1 | NOLONGERAVAILABLE | Inc | No | | |
| 121 | 614796-00 | 1 | SIDEHANDLE | Antivibration | | No | |
| 123 | 945292-00 | 1 | NUT M7 | Yes | | | |
| 124 | 944575-00 | 1 | BUTTON | No | | | |
| 125 | 562210-00 | 1 | SPRING | No | | | |
| 126 | 944571-00 | 1 | SPINDLELOCK | No | | | |
| 128 | 641823-00 | 1 | SLEEVE | No | | | |
| 129 | 401623-00 | 1 | BAFFLE | No | | | |
| 130 | 949638-01 | 2 | BUFFER | No | | | |
| 132 | 606574-01 | 2 | BRUSHHOLDER | Inc133 | No | | |
| 133 | 562204-00 | 2 | SPRING | No | | | |
| 134 | 000000-00 | 1 | NOLONGERAVAILABLE | Inc171 | No | | |
| 135 | 605040-02 | 1 | BEARING 607(7x19x6) | No | | | |
| 136 | 000000-00 | 1 | NOLONGERAVAILABLE | No | | | |
| 137 | 611540-00 | 1 | SUPPORT | No | | | |
| 138 | 401680-00 | 1 | WRENCH | No | | | |
| 139 | 562097-05 | 1 | SCREW | No | | | |
| 140 | 401622-01 | 1 | FLANGE | No | | | |
| 145 | 562097-00 | 2 | SCREW | 4.2x13mm | | Yes | |

PartsList D28129 SMALLANGLEGRINDER 1

| Item | PartNumber | Qty | PartDescription | GeneralDescription | OtherInfo | RepairInst | Markets |
|------|------------|-----|-------------------|--------------------|-----------|------------|---------|
| 153 | 000000-00 | 1 | NOLONGERAVAILABLE | | | No | |
| 160 | N110359 | 1 | BEARING | | | No | |
| 162 | 611737-01 | 1 | LINK | No | | | |
| 163 | 569624-01 | 1 | BUTTON | Black | No | | |
| 164 | 562097-13 | 1 | SCREW | Yes | | | |
| 166 | 398906-00 | 1 | SPACERINSULATING | | | Yes | |
| 171 | 393799-00 | 1 | ORING | | | Yes | |
| 800 | 286436-00 | 1 | GREASE | 500gms | | Yes | |
| 821 | 000000-00 | 1 | NOLONGERAVAILABLE | | | No | |



800

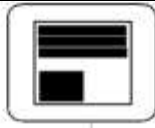

821

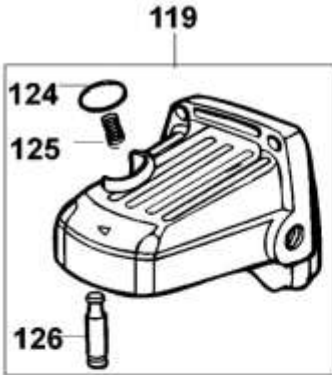

119

124

125

126

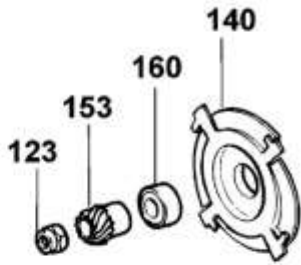

140

160

123

153

130

129

101

135

128

166



104

132

133

145

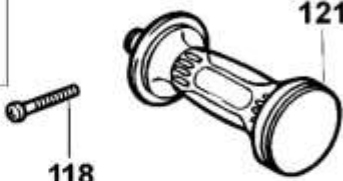

118

121

134



171



114

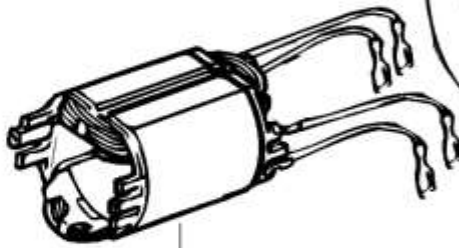

102

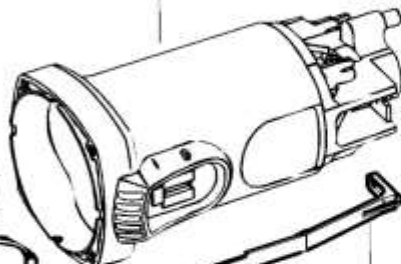

163

162



112

136

164

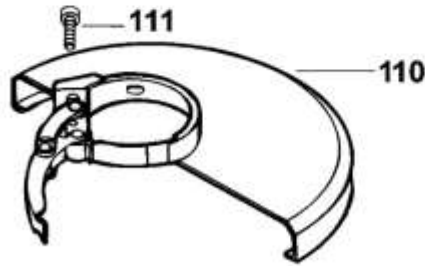
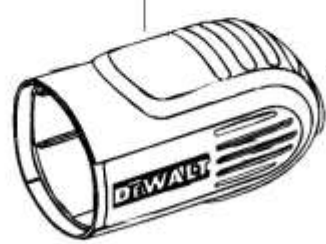

111

110

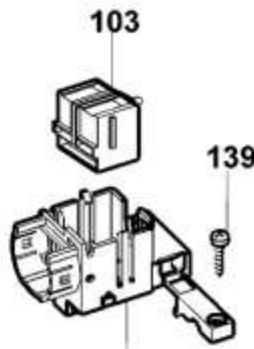

103

137

139

107

106

138

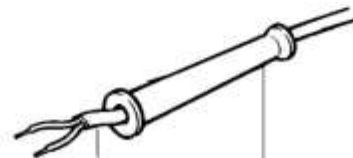

105

116