

1. Настройка на изпразващ механизъм

Settings for outlet valve

1. Отстранете скобите 1, откопчайте рейките 2 и извадете стълбата 3

Remove the clips 1, take out the rods 2 and pull up the ladder 3

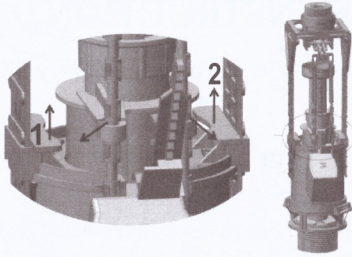

2. Завъртате червената тръба 4 надясно и я премествате на желаната буква

Turn the red pipe 4 clockwise and move it to the desired letter

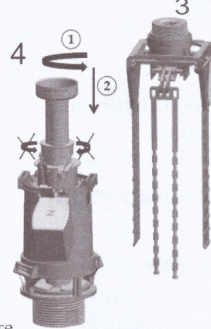

4. Изрежете излишната част от рейките 1

Cut the unnecessary part of the rods 1

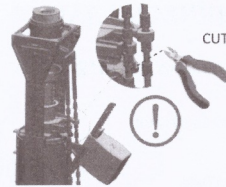

3. Завъртате наляво за заключване на тръбата. Поставете стълбата 3, закопчавате скобите 1 и рейките 2

Turn the pipe counterclockwise to lock it. Put the ladder 3, click the clips 1 and the rods 2

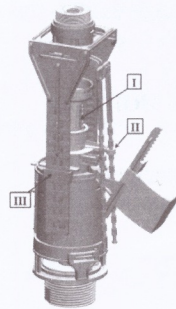
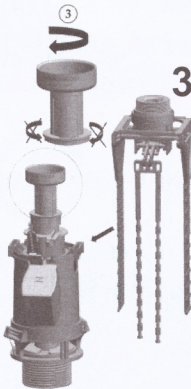

Най-масовите настройки са:

Most common settings:

I	II	III
A	4	min S7
D	3	min S6
G	2	min S5

5. Регулиране на 3-те литра обем изпусната вода

Adjust the 3 L volume of discharged water

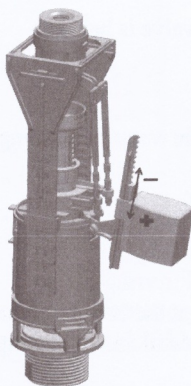

6. Регулиране нивото остатъчна вода в казанчето след изпускане на водата. Влияе на количеството изпусната вода!

Residual water level adjustment after the flush. This setting has influence on the volume of the discharged water.

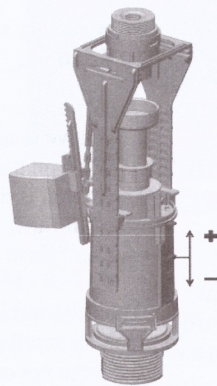

7. Задължително условие преди монтаж!

Mandatory condition before installation.

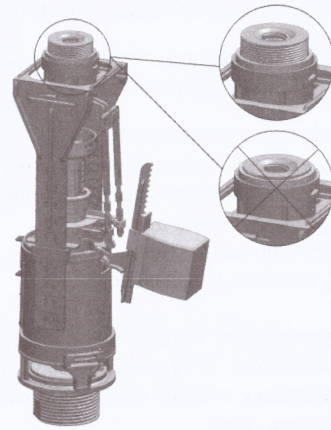

Настройка на пълнеж механизъм

Settings for inlet valve

Смяна на филтъра
Change of filter

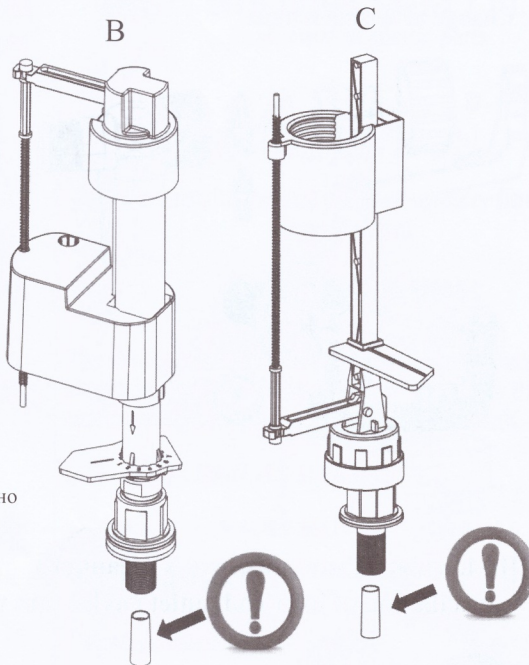

ВАЖНО: За нормалното функциониране на пълнещите механизми,
е необходимо филтъра да се почиства периодично.



Important: For the normal function of the filling valves, the filter
has to be cleaned periodically.

Регулиране количеството вода в казана
Adjustment of the water level into the tank

